



GENERAL FEATURES

- Environmentally friendly
- Wide operating temperature range
- Nano gel electrolyte and long Floating service Life
- Can be used at vertical or horizontal orientation
- High Power Density
- Low self discharge

DIMENSIONS & WEIGHT

Length(mm)	198±1
Width(mm)	166±1
Height(mm)	174±1
Total Height(mm)	174±1
Weight(kg)	13.0±3%

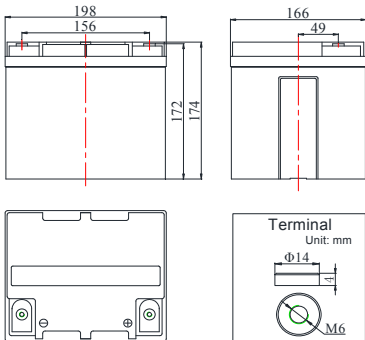

COMPLIED STANDARDS

IEC 60896-21/22	JIS C8704
YD/T1360	BS6290 part4
GB/T 19638	UL 1989

APPLICATIONS

- Telecom Control Equipments
- UPS systems
- Communication Equipments
- Medical Equipments
- Emergency Power Systems
- Security Systems
- Cable TV
- Railway System



TECHNICAL SPECIFICATIONS

Art. no: SAGS12-42

Nominal Voltage		12V(6 cells per unit)
Design Floating Life @25°C		12 Years
Nominal Capacity @25°C(10 hour rate@4.20A,10.80V)		42Ah
Capacity @25°C	20 hour rate (2.25A,10.5V)	45.0Ah
	5 hour rate (7.4A,10.5V)	37.0Ah
	1 hour rate (26.8A,9.6V)	26.8Ah
Internal Resistance	Full Charged Battery@25°C	≤9.5mΩ
Ambient Temperature	Discharge	-30°C~60°C
	Charge	-30°C~60°C
	Storage	-30°C~60°C
Max.Discharge Current@25°C		420A(5s)
Capacity affected by Temperature (10 hr Capacity)	40°C	108%
	25°C	100%
	0°C	90%
	-15°C	70%
Self-Discharge@25°C per Month		3%
Charge (Constant Voltage) @25°C	Standby Use	Initial Charging Current Less than 10.5A Voltage 13.6-13.8V
	Cycle Use	Initial Charging Current Less than 10.5A Voltage 14.4-14.9V

BATTERY DISCHARGE TABLE

Discharge Constant Current per Cell (Amperes at 25°C)

F.V/Time	15min	30min	45min	1h	2h	3h	5h	6h	8h	10h	20h
1.60V	75.8	44.6	33.8	26.8	15.8	11.6	7.8	6.8	5.3	4.4	2.33
1.67V	71.6	42.3	32.5	26.0	15.2	11.2	7.7	6.7	5.3	4.3	2.31
1.70V	67.2	41.1	31.3	25.0	14.8	10.9	7.5	6.6	5.2	4.3	2.28
1.75V	63.0	39.3	29.9	24.0	14.4	10.7	7.4	6.4	5.1	4.2	2.25
1.80V	59.1	37.8	28.9	23.1	13.9	10.3	7.2	6.3	5.0	4.2	2.23

Discharge Constant Power per Cell (Watts at 25°C)

F.V/Time	15min	30min	45min	1h	2h	3h	5h	6h	8h	10h	20h
1.60V	144.9	88.7	64.2	51.4	29.9	22.1	15.1	13.1	10.4	8.6	4.6
1.67V	138.7	83.1	62.0	50.0	29.1	21.5	14.8	12.9	10.3	8.5	4.6
1.70V	129.2	81.3	60.1	48.3	28.4	21.0	14.6	12.8	10.2	8.4	4.5
1.75V	121.3	77.4	57.7	46.5	27.7	20.6	14.4	12.6	10.1	8.4	4.5
1.80V	113.8	74.3	55.7	45.0	26.8	20.0	14.1	12.3	10.0	8.3	4.4





PERFORMANCE CHARACTERISTICS

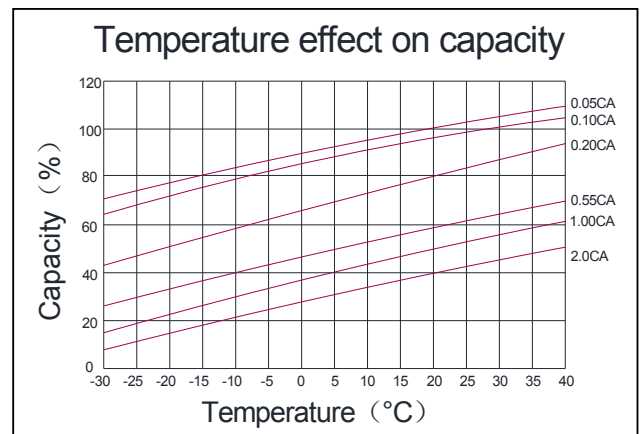
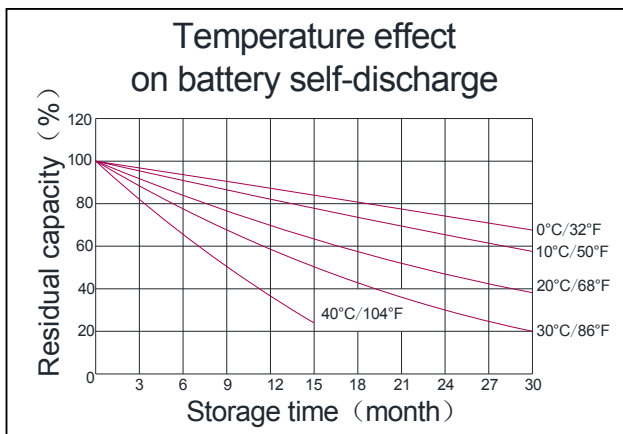
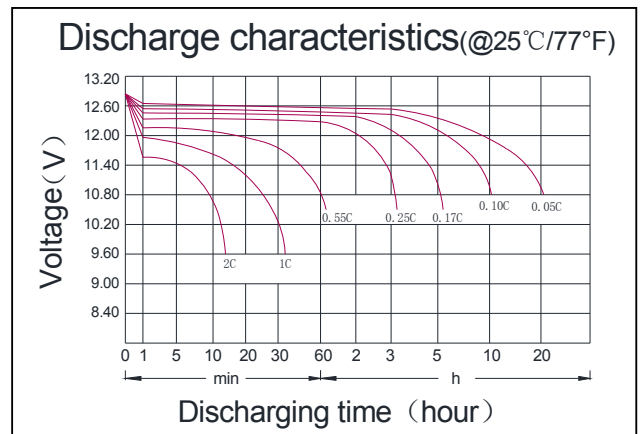
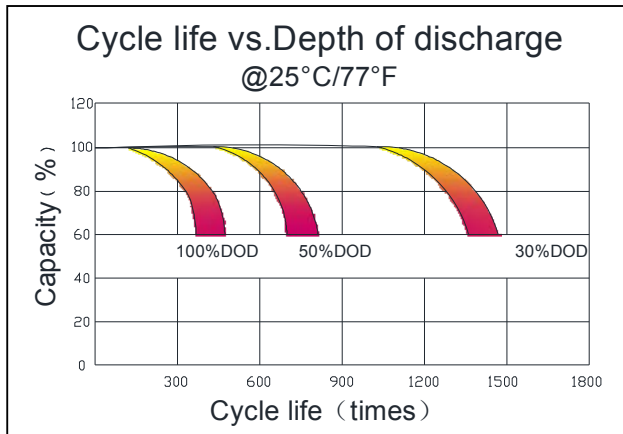
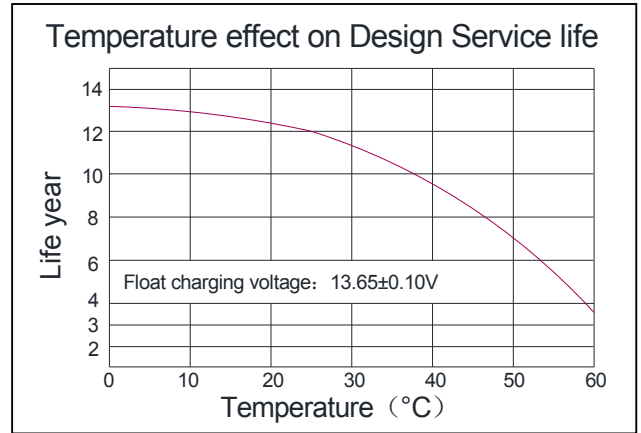
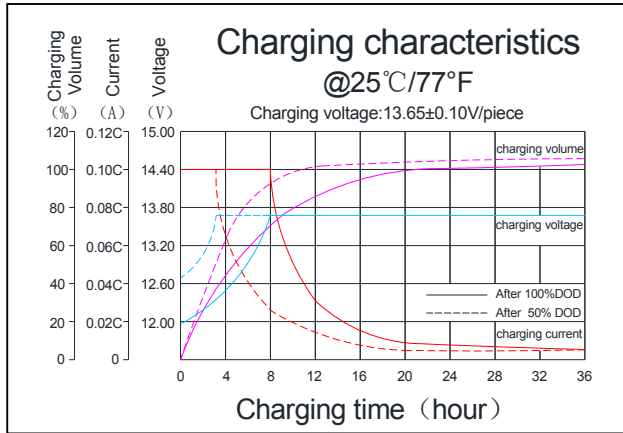

BATTERY CONSTRUCTION

Component	Positive plate	Negative plate	Container & Cover	Safety valve	Terminal	Separator	Electrolyte	Pillar seal
Features	Thick high Sn low Ca grid with special paste	Balanced Pb-Ca grid for improved recombination efficiency	ABS (UL94-V0 optional)	Flame Si-Rubbeand aging resistanacer	Female Copper Insert M6(torque:4 ~6N.m)	Advanced AGM separator for high pressure cell design	Dilute high purity sulphuric acid	Two layers epoxy resin seal

