



GENERAL FEATURES

- Environmentally friendly
- Thick plate with high Tin low Calcium alloy
- High Reliability and Good Quality
- Deep Discharge Recovery
- High Power Density
- Long Service Life, in Float or Cyclic

APPLICATIONS

- Solar & Wind energy system
- Cable TV Systems
- Telecom systems
- Wheel chair & Golf Car
- Marine Equipment
- Railway Systems
- Emergency Power System



DIMENSIONS & WEIGHT

Length(mm)	229±1
Width(mm)	138±1
Height(mm)	208±1
Total Height(mm)	212±1
Weight(kg)	16.0±3%

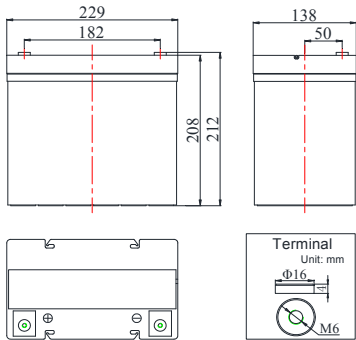

COMPLIED STANDARDS

IEC 60896-21/22	JIS C8704
YD/T799	BS6290 part4
GB/T 19638	UL 1989

TECHNICAL SPECIFICATIONS

Art. no: TRAS012-55

Nominal Voltage		12V(6 cells per unit)
Design Floating Life @25°C		12 Years
Nominal Capacity @25°C(20 hour rate@2.75A,10.50V)		55Ah
Capacity @25°C	10 hour rate (5.17A,10.8V)	51.7Ah
	5 hour rate (8.7A,10.5V)	43.5Ah
	1 hour rate (30.6A,9.6V)	30.6Ah
Internal Resistance	Full Charged Battery@25°C	≤9.6mΩ
Ambient Temperature	Discharge	-20°C~50°C
	Charge	-20°C~50°C
	Storage	-20°C~50°C
Max.Discharge Current@25°C		550A(5s)
Capacity affected by Temperature (10 hr Capacity)	40°C	102%
	25°C	100%
	0°C	85%
	-15°C	65%
Self-Discharge@25°C per Month		3%
Charge (Constant Voltage) @25°C	Standby Use	Initial Charging Current Less than 12.4A Voltage 13.6-13.8V
	Cycle Use	Initial Charging Current Less than 12.4A Voltage 14.4-14.9V

BATTERY DISCHARGE TABLE

Discharge Constant Current per Cell (Amperes at 25°C)

F.V/Time	15min	30min	45min	1h	2h	3h	5h	8h	10h	20h	100h
1.60V	70.8	45.2	33.2	30.6	19.4	13.6	9.2	6.1	5.45	2.92	0.66
1.67V	69.5	44.4	32.6	30.0	19.0	13.4	9.1	6.0	5.34	2.86	0.65
1.70V	68.2	43.6	32.0	29.4	18.7	13.1	8.9	5.9	5.23	2.81	0.63
1.75V	66.9	42.7	31.4	28.9	18.3	12.9	8.7	5.8	5.17	2.75	0.62
1.80V	64.4	41.1	30.2	27.8	17.6	12.4	8.4	5.6	5.01	2.72	0.61

Discharge Constant Power per Cell (Watts at 25°C)

F.V/Time	15min	30min	45min	1h	2h	3h	5h	8h	10h	20h	100h
1.60V	136.2	87.0	64.0	58.7	37.3	26.2	17.8	11.7	10.5	5.7	1.27
1.67V	133.8	85.4	62.8	57.6	36.6	25.7	17.5	11.6	10.3	5.6	1.24
1.70V	131.3	83.8	61.6	56.5	36.0	25.2	17.2	11.3	10.1	5.5	1.22
1.75V	128.8	82.2	60.4	55.5	35.3	24.8	16.8	11.1	9.9	5.4	1.20
1.80V	123.9	79.1	58.1	53.4	33.9	23.8	16.2	10.7	9.5	5.3	1.18





PERFORMANCE CHARACTERISTICS

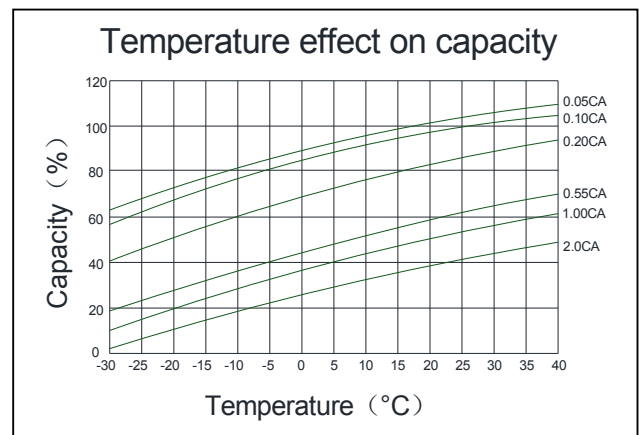
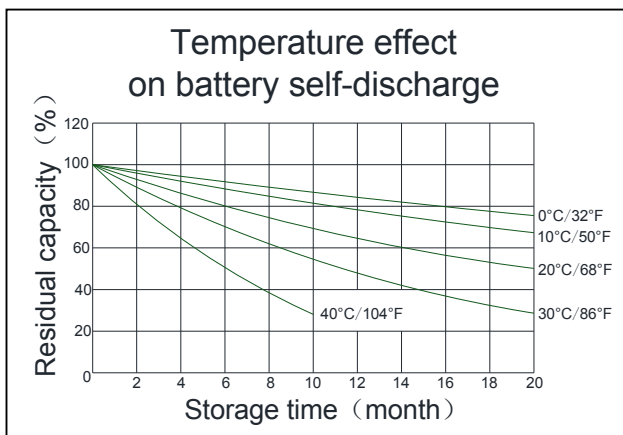
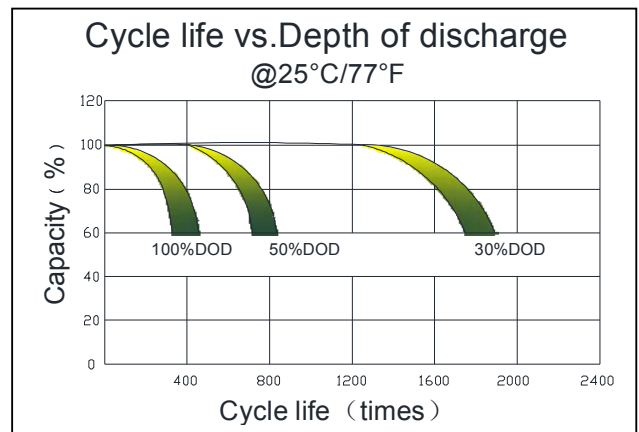
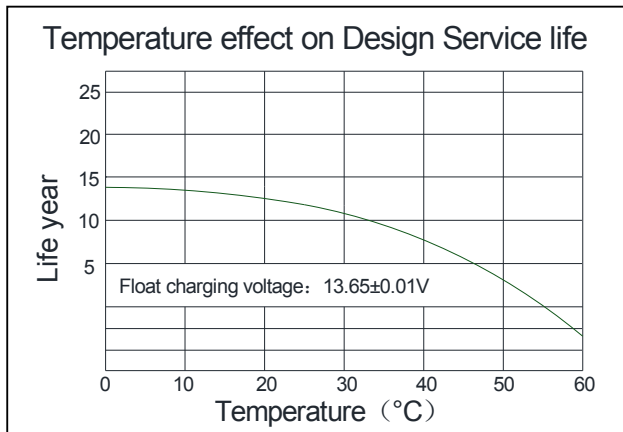
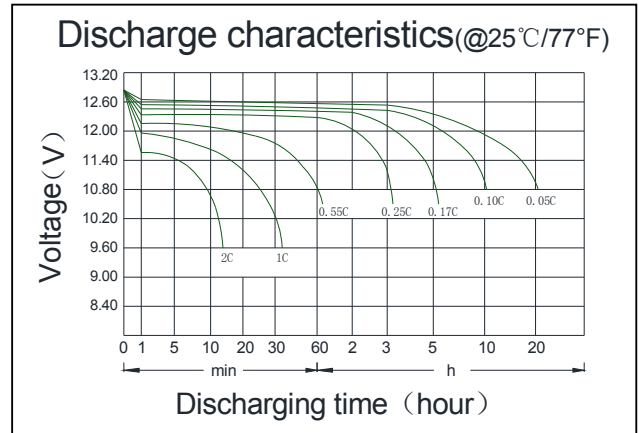
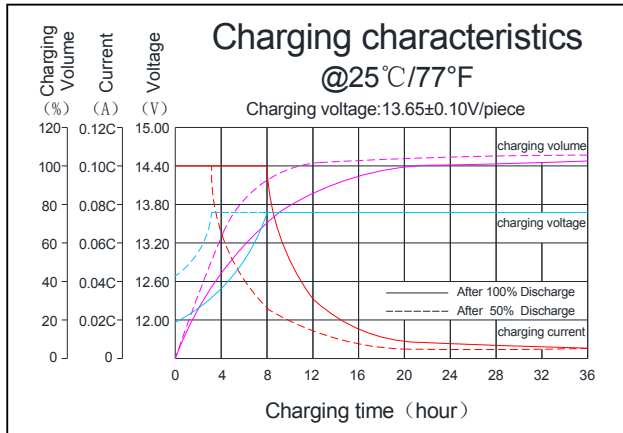

BATTERY CONSTRUCTION

Component	Positive plate	Negative plate	Container & Cover	Safety valve	Terminal	Separator	Electrolyte	Pillar seal
Features	Thick high Sn low Ca grid with special paste	Balanced Pb-Ca grid for improved recombination efficiency	ABS (UL94-V0 optional)	Flame Si-Rubbeand aging resistancer	Female Copper Insert M6(torque:4 ~6N.m)	Advanced AGM separator for high pressure cell design	Dilute high purity sulphuric acid	Two layers epoxy resin seal

